

PIN A1
Index Area

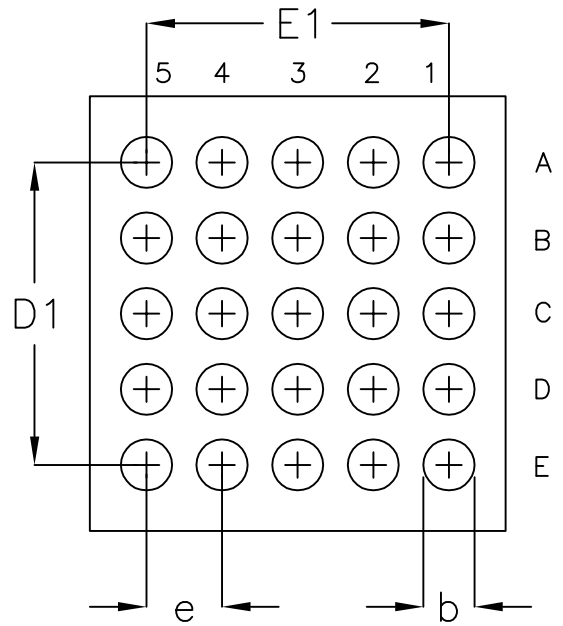
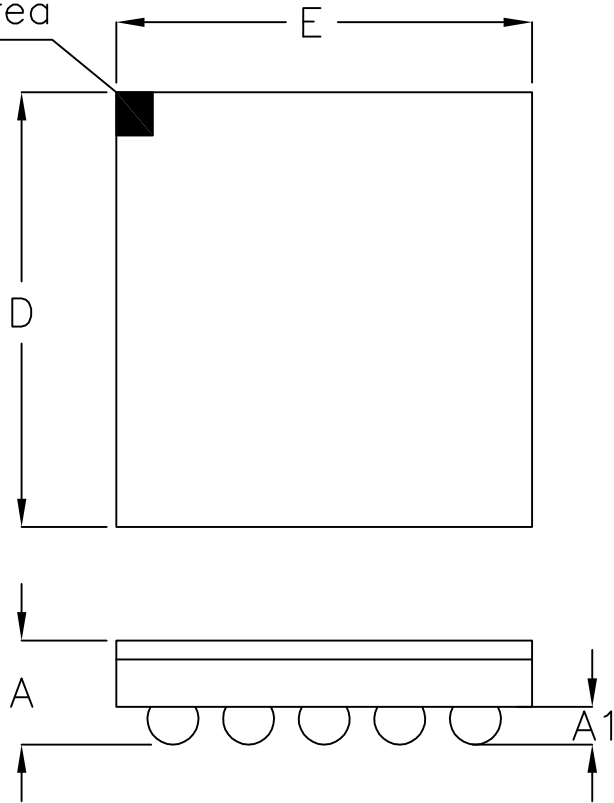

Symbol	Dimensions In Millimeters		Dimensions In Inches	
	Min	Max	Min	Max
A	0.500	0.600	0.020	0.024
A1	0.170	0.230	0.007	0.009
b	0.240	0.300	0.009	0.012
D	2.260	2.340	0.089	0.092
D1	1.600		0.063	
E	2.160	2.240	0.085	0.088
E1	1.600		0.063	
e	0.400		0.016	