

10W Stereo Class-D Speaker Driver with Headphone Amplifier Evaluation Board

Purpose

The RT9118 is a Audio Amplifier the input voltage range from 8V to 17V. This document explains the function and use of the RT9118 evaluation board (EVB), and provides information to enable operation, modification of the evaluation board and circuit to suit individual requirements.

Table of Contents

Purpose	1
Introduction.....	2
Key Performance Summary Table	2
Bench Test Setup Conditions	3
Schematic, Bill of Materials & Board Layout	5
More Information.....	9
Important Notice for Richtek Evaluation Board	9

Introduction

General Product Information

The RT9118 is a 10W per channel, high efficiency Class D stereo audio amplifier for driving bridge tied load (BTL) speakers. The RT9118 can drive stereo speakers with load as low as 4Ω. Its high efficiency eliminates the need for an extra heat sink when playing music. The gain of the amplifier can be controlled by gain select pins. The outputs are fully protected against shorts to GND, PVCC, and output to output with an auto recovery feature and monitored output.

Product Feature

- **8V to 17V Input Supply Range**
 - ▶ **10W / CH for an 8Ω Load, 13V Supply at 10% THD + N**
 - ▶ **15W / CH for an 8Ω Load, 16V Supply at 10% THD + N**
 - ▶ **90% Efficiency Eliminates Need for Heat Sinks**
- **Two Selectable Gain Settings**
- **Over-Temperature Protection (OTP) with Auto Recovery Option**
- **Surface Mount 28-Lead WQFN Package**

Key Performance Summary Table

Key Features	Evaluation Board Number : PCB086_V1
PVCC Input Voltage	12V
HPVDD Input Voltage	5V
Speaker Output Power (Load=8Ω, THD+N=10%)	9W
Headphone Output Power (Load=16Ω, THD+N=1%)	30mW
Marking & Package Type	RT9118GQW, WQFN-28L 4x5

Bench Test Setup Conditions

Headers Description and Placement

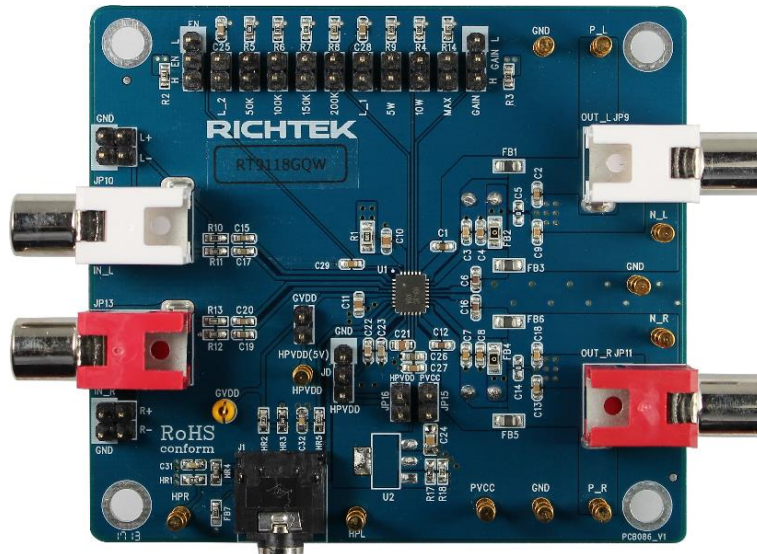

Carefully inspect all the components used in the EVB according to the following Bill of Materials table, and then make sure all the components are undamaged and correctly installed. If there is any missing or damaged component, which may occur during transportation, please contact our distributors or e-mail us at evb_service@richtek.com.

Test Points

The EVB is provided with the test points and pin names listed in the table below.

Test point/ Pin name	Signal	Comment (expected waveforms or voltage levels on test points)
PVCC	Input power supply	Power input. Support 8V to 17V Input Voltage.
EN	Enable test point	High = Enable, Low = Disable.
GND	Ground	Ground.
Audio IN	Analog source input	Stereo analog source input.
SPK OUT	Speaker Output	Stereo analog to Speaker Amplifier. (Left & Right Channel Output)
HP OUT	Headphone Output	Stereo analog to Headphone Amplifier. (Headphone Output)
Gain	Gain setting	Gain test-pin, High = 31dB, Low = 26dB.
Plimit	Plimit setting	Power Limit Level. (5W, 10W, MAX) (Short = Enable, Open = Disable)

Power-up & Measurement Procedure

1. Connect input power supply ($8V < PVCC < 17V$) and ground to PVCC and GND pins respectively.
2. Connect input power supply (HPVDD = 5V) and ground to HPVDD and GND pins respectively.
3. The 1X3 Header (GAIN) is the Gain setting. (High = 32dB, Low = 26dB).
4. The 1X2 Header (5W, 10W, MAX) is the Plimit setting. (Short = Enable, Open = Disable).
5. The 1X3 Header (JD) is the JD setting. (High = HP mode, Low = SPK mode).
6. Connect stereo analog source input to IN_L (L_CH Input), IN_R (R_CH Input) RCA Jack.
7. Connect speaker to the GP1 (P_L), GP2 (N_L), GP3 (P_R), GP4 (N_R).
8. Connect headphone to the GP5 (HPL), GP8 (HPR).
9. The 1X3 Header (EN) is the Enable controlled. (High = Enable, Low = Disable).

Schematic, Bill of Materials & Board Layout

EVB Schematic Diagram

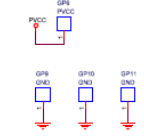
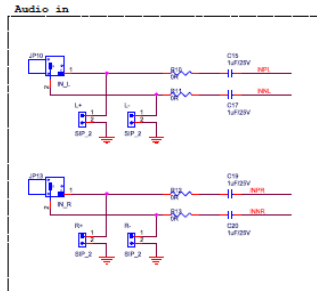
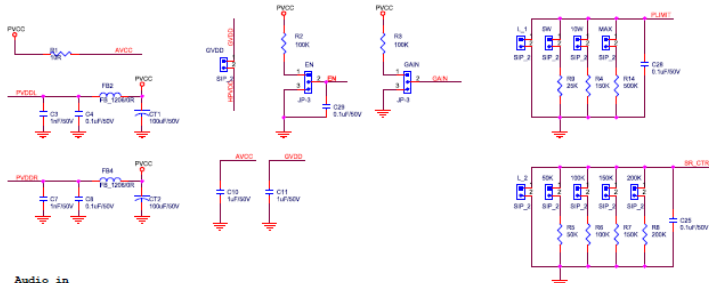

LD0 12V-17V to 5V (RT9116 NC)

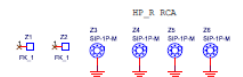
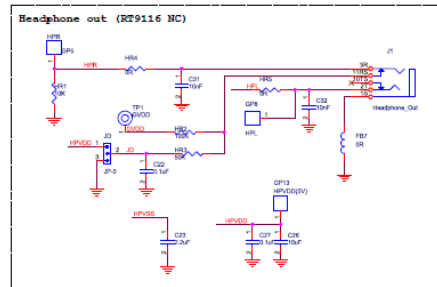
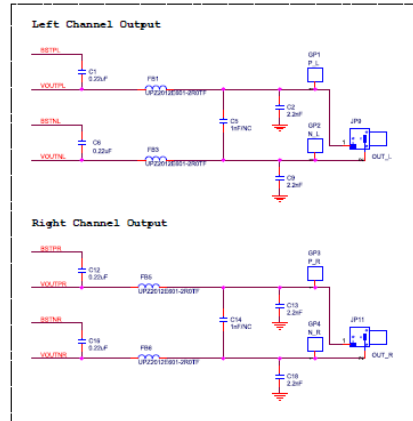
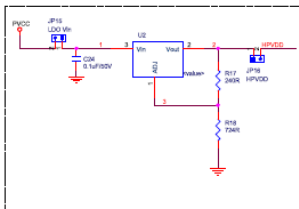

Bill of Materials

Reference	Qty	Part number	Description	Package	Manufacturer
U1	1	RT9118GQW	10W stereo Class-D Speaker Amplifier	WQFN-28L 4x5	Richtek
CT1, CT2	2	CT100F	100 μ F/50V	EC-2P_8	JACKCON
C1, C6, C12, C16	4	C1608X5R1C224K	0.22 μ F/16V/X5R	C-0603	TDK
C2, C9, C13, C18	4	C1608X5R1H222K	2.2nF/50V/X5R	C-0603	TDK
C3, C7	2	C1608X5R1H102K	1nF/50V/X5R	C-0603	TDK
C4, C8, C25, C28, C29	5	C1608X5R1H104K	0.1 μ F/50V/X5R	C-0603	TDK
C10, C11, C21	3	C1608X5R1H105K	1 μ F/50V/X5R	C-0603	TDK
C15, C17, C19, C20	4	C1608X5R1E105K	1 μ F/25V/X5R	C-0603	TDK
C22, C27	2	C1608X5R1E104K	0.1 μ F/25V/X5R	C-0603	TDK
C23	1	C2012X5R1C225K	2.2 μ F/16V/X5R	C-0805	TDK
C26	1	C2012X5R1C106K	10 μ F/16V/X5R	C-0805	TDK
C31, C32	2	C1608X5R1H103K	10nF/50V/X5R	C-0603	TDK
FB1, FB3, FB5, FB6	4	UPZ2012E601-2R0TF	600 Ω \pm 25%	0805	Sunlord
FB2, FB4	2	RTT05000JTP	0R/0805/ \pm 5%	R-0805	Ralec
FB7, R10, R11, R12, R13	5	WR06X000PTL	0R/0603/ \pm 1%	R-0603	WALSIN
J1	1	Headphone Jack	Headphone_Out	LJE0364-5	Lih Sheng
R1	1	WR08X10R0FTL	10R/0805/ \pm 1%	R-0805	WALSIN
R2, HR2, R3, R6	4	WR06X1003FTL	100K/0603/ \pm 1%	R-0603	WALSIN
R4, R7	2	WR06X1503FTL	150K/0603/ \pm 1%	R-0603	WALSIN
R8	1	WR06X2003FTL	200K/0603/ \pm 1%	R-0603	WALSIN
R9	1	WR06X2492FTL	24.9K/0603/ \pm 1%	R-0603	WALSIN
R14	1	WR06X4993FTL	499K/0603/ \pm 1%	R-0603	WALSIN
HR1	1	WR06X1002FTL	10K/0603/ \pm 1%	R-0603	WALSIN
HR3, R5	2	RTT034992FTP	49.9K/0603/ \pm 1%	R-0603	Ralec
HR4, HR5	2	WR06W2R20FTL	2.2R/0603/ \pm 1%	R-0603	WALSIN

PCB Layout

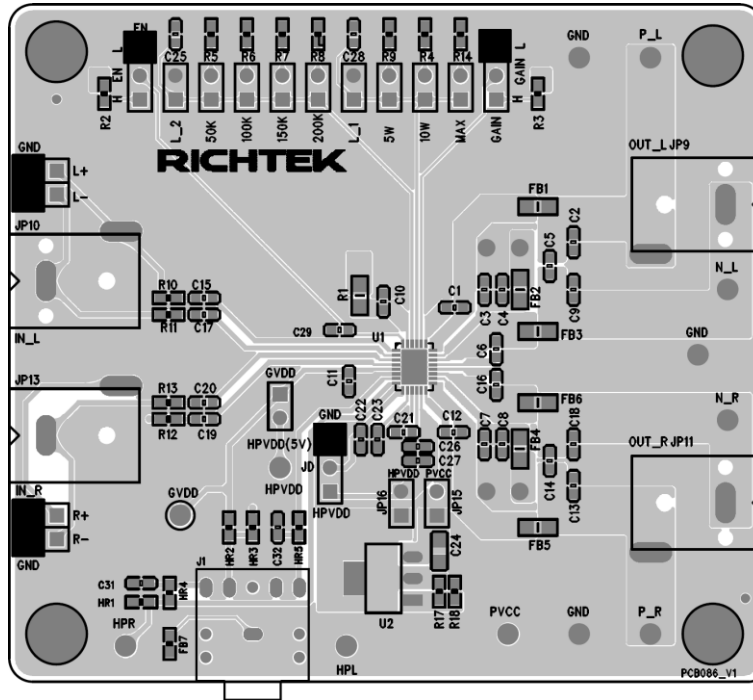

Top View (1st layer)

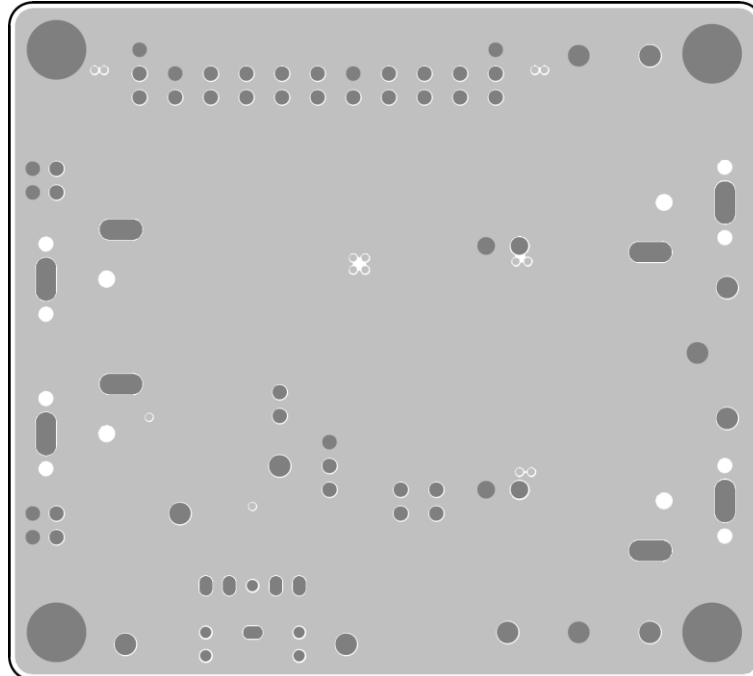

PCB Layout—Inner Side (2nd Layer)

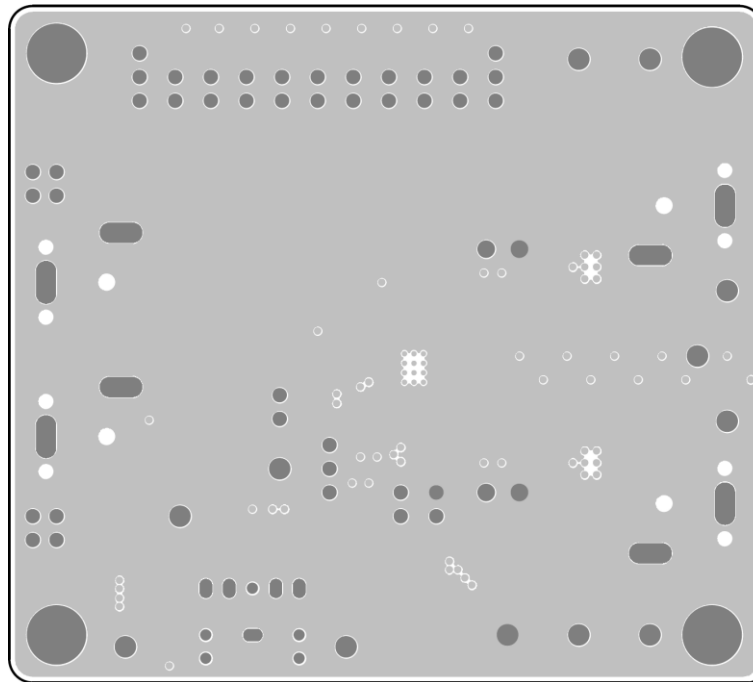

PCB Layout—Inner Side (3rd Layer)

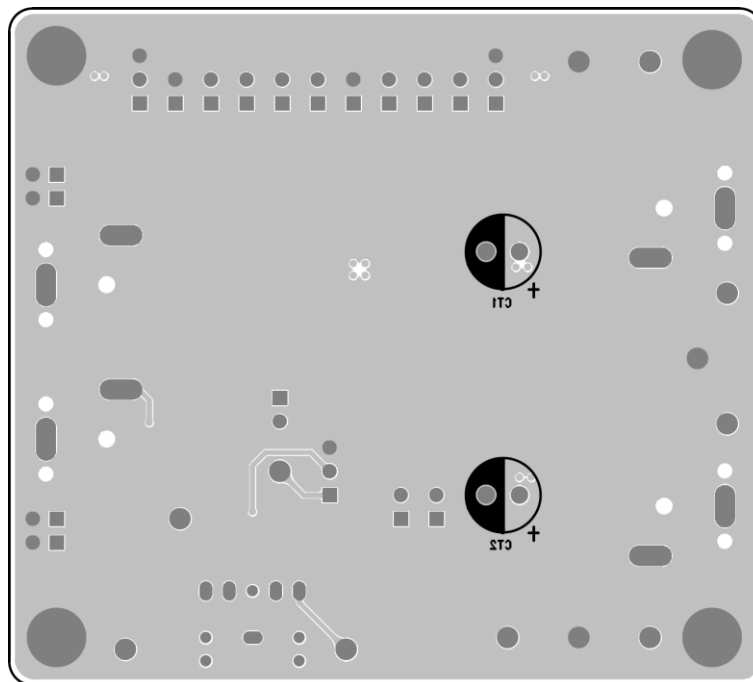

Bottom View (4th Layer)

More Information

For more information, please find the related datasheet or application notes from Richtek website <http://www.richtek.com>.

Important Notice for Richtek Evaluation Board

THIS DOCUMENT IS FOR REFERENCE ONLY, NOTHING CONTAINED IN THIS DOCUMENT SHALL BE CONSTRUED AS RICHTEK'S WARRANTY, EXPRESS OR IMPLIED, UNDER CONTRACT, TORT OR STATUTORY, WITH RESPECT TO THE PRESENTATION HEREIN. IN NO EVENT SHALL RICHTEK BE LIABLE TO BUYER OR USER FOR ANY AND ALL DAMAGES INCLUDING WITHOUT LIMITATION TO DIRECT, INDIRECT, SPECIAL, PUNITIVE OR CONSEQUENTIAL DAMAGES.